

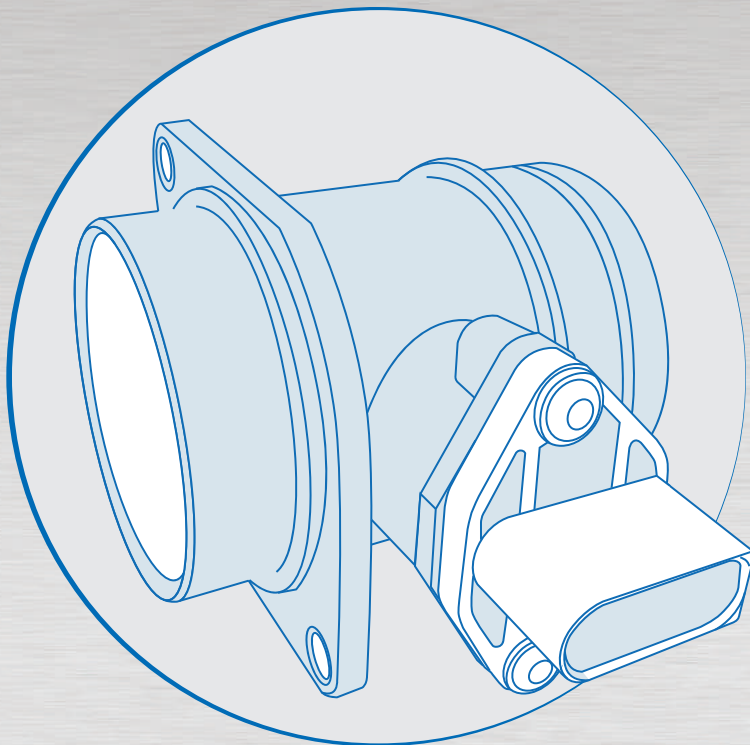

Medidor de Fluxo de Ar - MAF

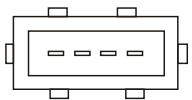

GH5052



SUBSTITUI:

Bosch: 0 280 217 111; **Fiat:** 60810813; Alfa Romeo: 46407008

APLICAÇÃO:

ALFA ROMEO: 145(930) 1.6, 1.7i 16V T.S. Hatchback 10.94-12.96 88 120 1598, 145(930) 1.8, 2.0 16V Hatchback 03.98-01.01 106 1441747, 145(930) 2.0 16V T.S. Hatchback 10.95-01.01 110 150 1970, 146(930) 1.6, 1.7, 1.8, 2.0 16V T.S. Hatchback 11.96-01.01 88 120 1598, 155(167) 1.6, 1.7, 2.0 16V T.S. Saloon 05.96-01.98 88 120 1598, 156(932) 1.6 16V T.Spark(932A4) Saloon 09.97 88 120 1598, Spider(916S_) 2.0 T.Spark 16V(916S2C00) 06.95 110 150 1970;

FIAT: Brava (182) 2.0 HGT 20V (182.AD) Hatchback 10.95-07.98 108 147 1998, Coupe (FA/175) 2.0 20V 96-98 108 147 1998, Marea / Weekend 2.0 20V 98-00 108 147 1998, Coupe 2.0 20V 96-98

GH5013

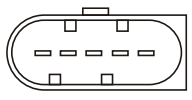

SUBSTITUI:

Bosch: 0 280 218 013; **VW:** 06B 133 471

APLICAÇÃO:

AUDI: A4 1.8 94-01 92 125 1781, A6 /Avant 1.8 99-01 92 125 1781;

VW: Passat /Variant 1.8 96-03 92 125 1781.

GH5014

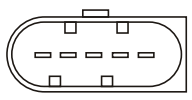

SUBSTITUI:

Bosch: 0 280 218 060; **VW:** 06A 906 461G

APLICAÇÃO:

AUDI: A3 1.8 98-03 92 125 1781, Audi Q7 4.2 FSI 06.08;

SEAT: Cordoba 2.0, Saloon 09.02 85 115 1984;

VW: Bora 2.0 10.98 85 115 1984, Golf IV 1.6 03-78 107 1595, Golf IV 2.0 01.07 85 115 1984, New Beetle 2.0 00-05 85 115 1984, New Beetle 1.8 T 04.05 150, Phaeton 4.2 V8 03-246 335 4172, Touareg 4.2 V8 02.06 228 310 4172.

GH5015

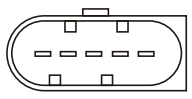

SUBSTITUI:

Bosch: 0 280 218 063, 280218064; **VW:** 06A 906 461L

APLICAÇÃO:

AUDI: A4 1.8 T Saloon/ Quat 00-04 110 150 1781, A3 1.8 T 150CV 12.96 110 150 1781, A3 1.8 T 180CV 00-03 180, A6 1.8 T 00-06 110 150 1781, TT 1.8 T 180CV 00-06 132 180 1781, TT 1.8 T 150 CV 01.06 150;

VW: Bora 1.8T 150CV 00-05, 180CV 02-03, Golf IV 1.8 T 150CV 00-03, 180CV 02-07, New Beetle 1.8 T 150CV 00-04, 180CV 01-05, Passat /Variant 1.8 T 00-05, Polo 1.8 GTI 05-, Jetta IV 1.8T 03.04 180CV;

SEAT: Ibiza IV 1.8 T 03>.

GH5024

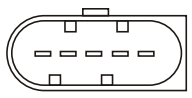

SUBSTITUI:

Bosch: 0 280 218 002, 0 986 280 205, 0 280 218 003; **VW:** 06A 906 461 A

APLICAÇÃO:

AUDI: A3 1.8 96-06 125 CV, A4 1.8T 99-00 112 CV;

SEAT: Toldedo II 1.8 20 V 04.99 125 CV;

VW: Bora 2.0 98-05 115 CV, Bora 1.8 98-00 125CV, Golf IV 1.8 97-00 125 CV, Golf IV 2.0 98-05 115 CV, New Beetle 1.8 T 98-01 150 CV, New Beetle 2.0 98-05 115 CV

GH5027

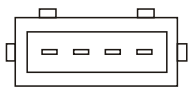

SUBSTITUI:

Bosch: 0 280 217 117; **VW:** 037 906 461 C; **Ford:** 98; **VW:** 12B529 BA

APLICAÇÃO:

AUDI: A3 1.8 T 99-06 110 150 1781, A4 / Avant 1.8 T 97-01 132 180 1781, A6 / Avant 1.8 T 150CV 97-99, 180 CV 97-00;

VW: Bora 1.8 T 00-05 110 150 1781, Golf IV Gti 1.8 T 99-02 110 150 1781, Passat/ Variant 1.8 T 99-00 110 150 1781.

GH5041

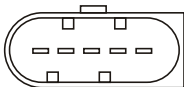
SUBSTITUI:

Bosch: 0 280 218 032, 0 280 218 033; **VW:** 06A 906 461 D

APLICAÇÃO:

AUDI: A3 1.8 T 150CV 99-03, 180CV 00-06, A4 1.8 T 150CV 08-00, A6 / Avant 1.8 T 150CV 98-01, TT 1.8 T 180CV 98-01;

SEAT: Cordoba 1.8 T 20V Cupra 99-02, Ibiza III 1.8 T 20V Cupra 99-02;

VW: Golf IV 1.8 T 150CV 99-00, Passat / Variant 1.8 T 150CV 99-00.

GH5061

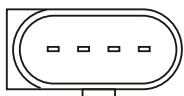
SUBSTITUI:

VW: 06A906461B; **Hella:** 8ET 009 142-261

APLICAÇÃO:

AUDI: A3 1.6 96- 74 101 1595, AUDI A4 / Avant 1.6 95-00 74 100 1595;

SEAT: Cordoba 1.6 99-02 74 101 1595, Ibiza III 1.6 99-02 74 101 1595;

VW: Golf IV 1.6 Hatchback 97-00 74 100 1595, Passat/Variant 2.0 00- 85 115 1984, Polo Classic 1.6 95-01 74 100 1595, Transporter IV Box 2.5 96- 85 115 2461

GH5063

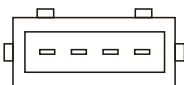
SUBSTITUI:

Bosch: 0 281 217 112, 0 280 217 013; **VW:** 058 133 471 A

APLICAÇÃO:

AUDI: A3 1.8 T 96-03 110 150 1781, A4 / Avant 1.8 T 94-98 110 150 1781, A6 1.8 T 97-99 110 150 1781;

VW: Passat / Variant 1.8T 96-00 110 150

GH5031

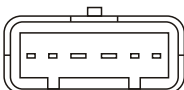
SUBSTITUI:

Siemens: 5WK9623; **Hella:** 8ET 009 142-141; **Citroën:** 1920.8Q; **Fiat:** 9628336380; **Peugeot:** 1920.8Q

APLICAÇÃO:

CITROËN: Jumper Box 2.0 HDI 02, Jumper Box 2.2 HDI 02, Jumper Bus 2.0 HDI 02, Jumper Bus 2.2 HDI 02, Jumper Flatbed/Chassis 2.0 HDI 02, Jumper Flatbed/Chassis 2.2 HDI 02;

FIAT: Ducato Box 2.0 JTD 01- 02, Ducato Box 2.0 JTD 02, Ducato Bus 2.0 JTD 01- 02, Ducato Bus 2.0 JTD 02,

Ducato Flatbed/Chassis 2.0 JTD 02;

PEUGEOT: Boxer Box 2.0 HDI 02, Boxer Box 2.2 HDI 02, Boxer Bus 2.0 HDI 02, Boxer Bus 2.2 HDI 02, Boxer Flatbed /Chassis 2.0 HDI 02, Boxer Flatbed /Chassis 2.2 HDI 02.

GH5091

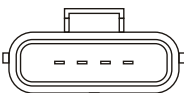

SUBSTITUI:

Ford: 1 030 844, 96 FP12B579 AB; **Pieburg:** 7.22184.04.0

APLICAÇÃO:

FORD: Fiesta IV 1.4 I 16V 04.92-01.02 66 90 1388, Fiesta 1.4 16V 11.01 59 80 1388, Ka 1.3 09.96, 08.02 44 60 1299.

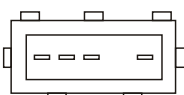
GH5093



SUBSTITUI:

Hella: 8ET 009 142-171; **Ford:** 93BB12B579BA, 6 848 047

APLICAÇÃO:

FORD: Escort 1.8 16V, Mondeo 1.8 16V 94-96.

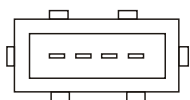
GH5047



SUBSTITUI:
Kia: 0K08013210
APLICAÇÃO:
KIA: Sportage 2000 cc MOT.2.0 i.e 03.99 2000

GH5003

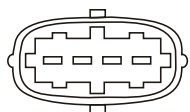

SUBSTITUI:
Bosch: 0 280 218 019
APLICAÇÃO:
ALFA: 145(930) 1.6 i.e.16V T.S.Hatchback 12.96-01.01 88 120 1598,145(930) 1.6 i.e.16V Hatchback 03.98-01.01 106 144 1598;
FIAT: Brava(182) 1.9 JTD 105 Hatchback 12.98-10.01 77 105 1910

GH5032

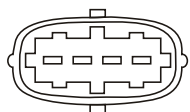

SUBSTITUI:
Bosch: 0 280 218 108; **Volvo:** 8670112, 8670263
APLICAÇÃO:
VOLVO: C70 2.0 T, 2.3 T, 2.5T 98-02 166 226 1984, Volvo S60 2.4 T 00-03 147 200 2435, Volvo S70 2.0, 2.3T, 2.4T 97-00 120 163 1984, Volvo S80 2.0, 2.0T, 2.4T, 2.9 98-06 120 163 1984, Volvo V70 I 2.0, 2.0T, 2.3, 2.4T, 2.5, 2.5T 97-00 120 163 1984, Volvo XC70 Cross Country 2.4 T XC AWD 00-02 147 200 2435

GH5078

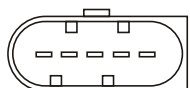

SUBSTITUI:
Bosch: 0 281 002 531; **VW:** 038 906 461B
APLICAÇÃO:
VW: Golf IV 2.0 99-02, Bora 1.8 98-00, New Beetle 1.8T 98-01;
AUDI: A3 1.8 99-06.